

# Pirate's Wallet Box



**a.k.a. *Stickman No. 27***

*Designed and made by Robert Yarger, 2014.*

(Ambrosia Maple / Redheart / Yellowheart, 6" x 8.25" x 6";  
includes a 3.5" x 7.25" black and white booklet  
with double sided cover, rear cover that is blank inside,  
and 8 double sided internal pages.)

This puzzle is all about the key and lock. Disassembly begins by taking them apart into pieces that are used in other steps.

The following pages show the booklet that was sold with the puzzle with some notes at the end. Little or no force is necessary for any of the steps, but some steps do require some amount of force, and humidity could cause more resistance. Unless you are very experienced with puzzle boxes, it may be better to just appreciate the art and follow the directions the first time you disassemble it; otherwise, you may end up applying too much force when exploring possible move options, and possibly damage the puzzle.

*Copyright J. A. Storer*

## Pirates Wallet Box Booklet

# Stickman®

No. 27

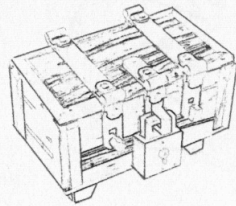

No. 27

## Pirate's Wallet Puzzle Box

### Quality

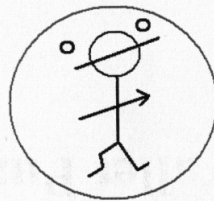

### Wooden Boxes

#### Instructions:

- 1: Rotate left knob counter-clockwise.
- 2: Lift up on latch and pull out, removing padlock from box.

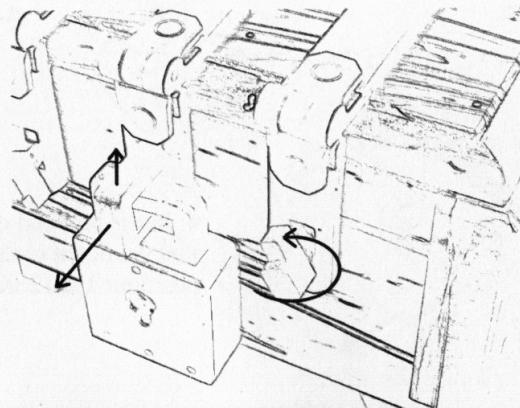

## Pirates Wallet Box Booklet Continued

3: Pull apart key shaft from handle.

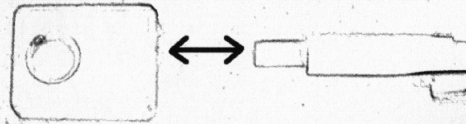
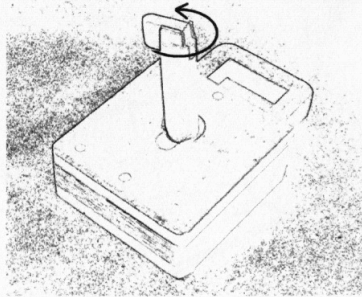

4: Insert butt end of key into padlock. Rotate so that the notch in the internal tumbler is positioned at 12:00.

5: Remove key, pull up on lock latch.

6: Lift out inner tab from latch.

7: Slide base to the left, and pull out from lock.

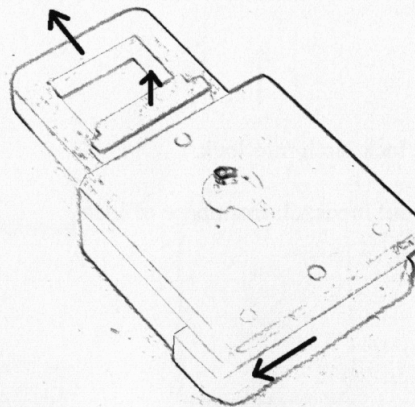

8: Push lock latch into lock.

9: Lift out inner tab from base of lock.

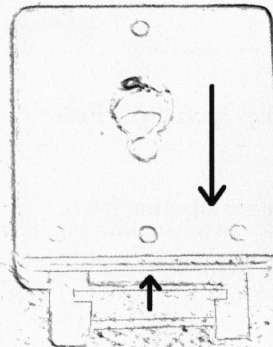

## Pirates Wallet Box Booklet Continued

10: Pull out latch handle from lock.

11: Remove inner tumbler disk by manipulating around peg inside of lock.

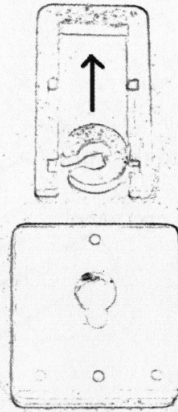

12: Slide lid to the right.

13: Lift up on end panel.

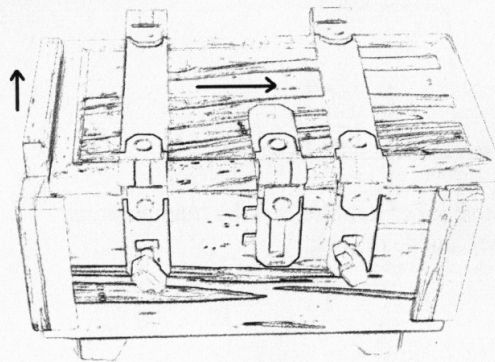

14: Insert latch handle into the notches of drawer at end of box.  
(It will snap and lock into place.)

15: Pull out drawer 1/4" using latch handle.

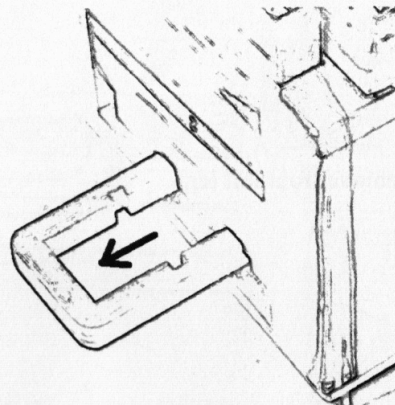

## Pirates Wallet Box Booklet Continued

16: Remove front left leg.

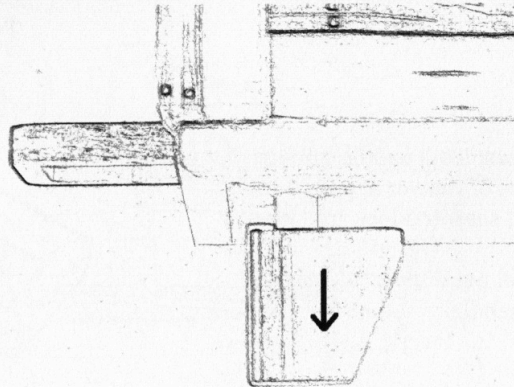

17: Pull drawer out fully using latch handle.  
(Note that drawer comes out partially and then must be pulled with more tension to extend fully.)

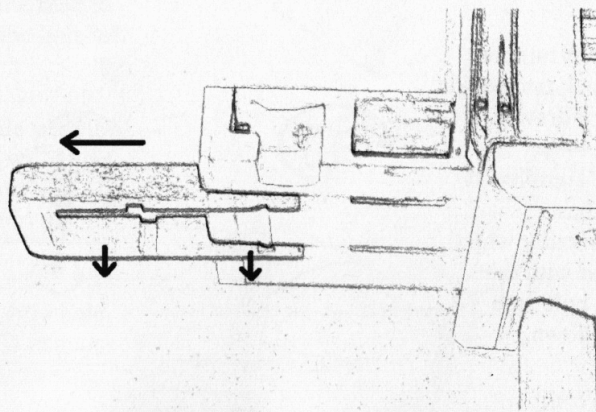

18: Remove latch handle from drawer by pulling downward.

19: Insert tumbler from lock into socket notch of drawer.

(Note: Tumbler works best mechanically when inserted with the square hole side facing down.)

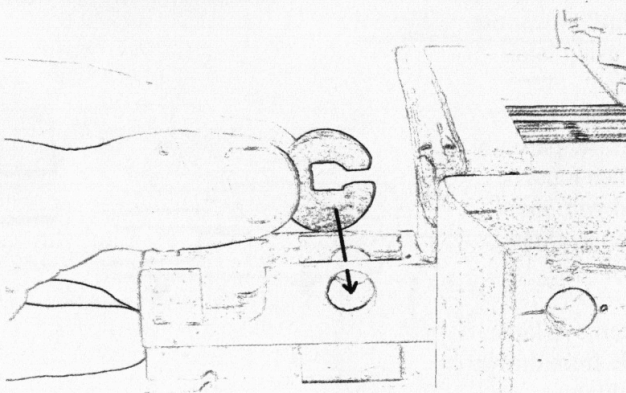

## Pirates Wallet Box Booklet Continued

20: Push in drawer until the hole in the drawer lines up with the hole left by the removed foot.

21: Position box on its side with the bottom facing you. (This will allow the tumbler disk to fall down and center itself with the hole in the base.)

22: Insert butt end of key into hole. Turn key clockwise until it engages the tumbler disk and stops turning.

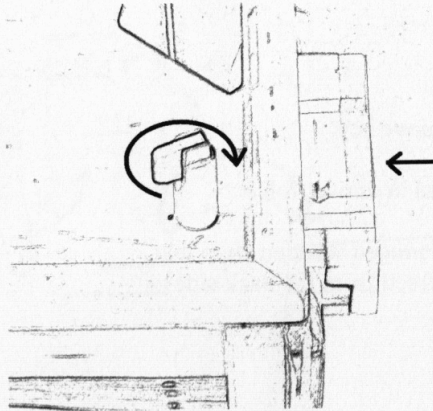

23: Remove key

24: Press in drawer fully.

25: Lift hinged wooden strap that is now freed from the back side of the box.

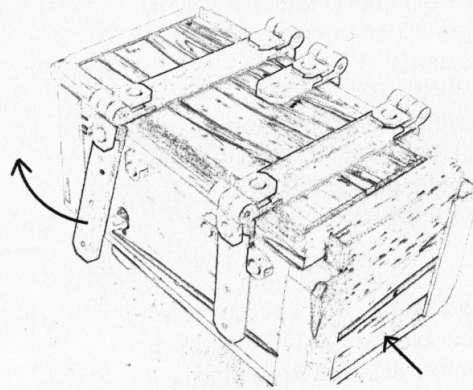

26: Close end panel of box.

27: Re-assemble key with its handle.

28: Insert key into hole revealed by wooden strap. (Key will push in partially, slide downward, and then can be fully inserted by rotating counter-clockwise.)

29: Rotate key clockwise.

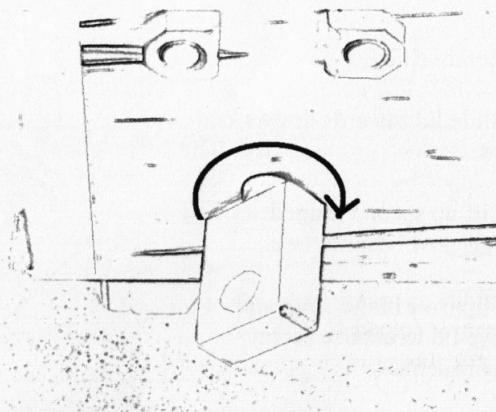

## Pirates Wallet Box Booklet Continued

### Re-Assembly:

Position drawers and internal mechanics exactly as they were found upon the solution of puzzle.

(Note that the sliding lock for the front side padlock latch is held in place by the top removable compartment. It should be inserted with the notched end facing down.)

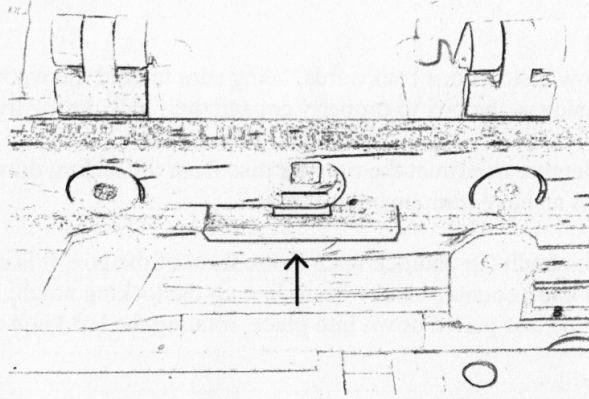

30: Remove key.

31: Slide lid towards drawer end of box.

32: Lift up second hinged strap that has now become free.

33: Flip over hinge strap and remove lid to expose secret compartments.

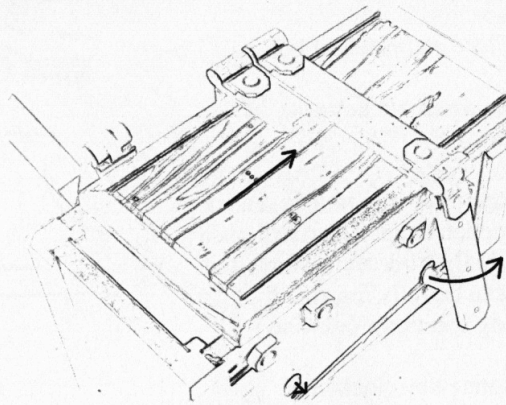

Follow instructions backwards, being sure to hold the wooden latches firmly to the backside of the box to properly engage their lock during their appropriate steps.

Remember to extract the tumbler disc from the sliding drawer at the proper step, as this is an easy component to forget.

To re-attach the padlock latch to the front of the box, it is necessary to rotate the right knob counter-clockwise to line up the locking notch. After the latch is inserted and pulled down into place, rotating the left knob clockwise will lock it.

## Pirates Wallet Box Booklet Continued

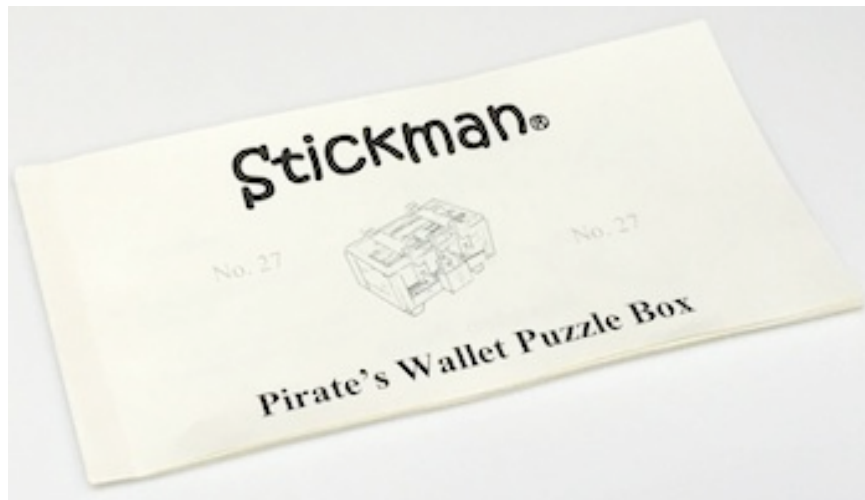
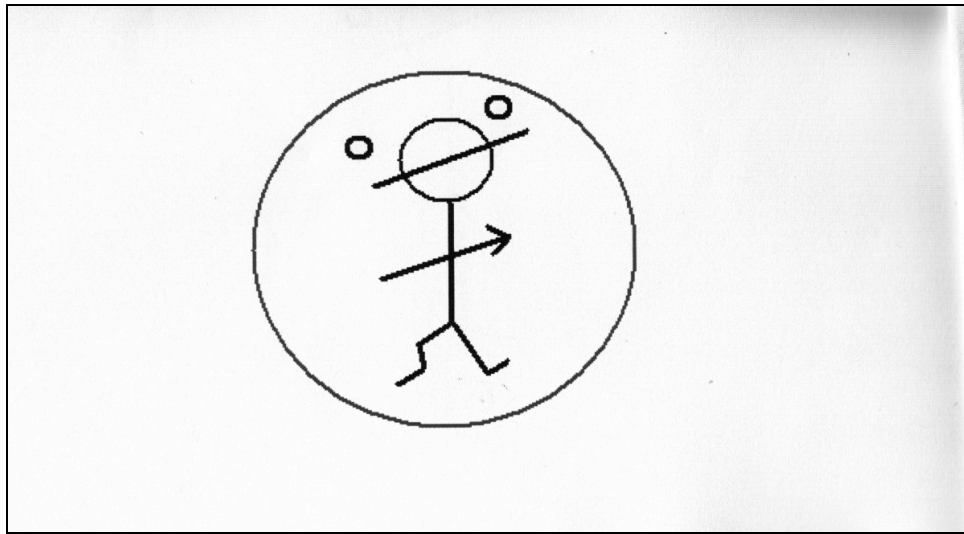



# Pirates Wallet Box Notes

## Disassembly

### All steps:

The legs are firm when the puzzle is fully solved, but may be loose during disassembly. The puzzle came with a note that no attempt should ever be made to rotate any of the legs.

### Steps 1 & 2:

The booklet says left knob but the figure shows turning the right knob. The knobs seem to spin and do nothing, but if you play with them you can get it so you can feel force on one when turning the other. I've found that the most repeatable way of pulling out the latch is to turn them both counterclockwise until the left one goes all the way back to 1 o'clock and will not turn further. Then the latch lifts up and out.

### Step 15:

If the drawer will not move a full 1/4" as it is supposed to, it may be due to a problem that can arise with shipping it or when it is vibrated in a particular way. A butter knife can be used to fix this problem; here are directions that were emailed to owners:

"If the drawer is stuck so it does not want to come out, insert a butter knife so that it is between the top of the drawer and the lifted up end panel of the box. The knife needs to go back at least 3", and should be inserted on top of the drawer (on the "left" side). Then drag the knife across the top of the drawer to the right. There is an internal peg that will slide and stop against the front face of the box internally. Once done, the drawer should come out as per the instructions, and this step should never again be necessary, unless the puzzle is turned on its back side and vibrated."

## Reassembly

The puzzle designer sent email to caution the user about not using force:

"The puzzle's internal mechanics can be arranged in such a way that its lower removable compartment can be inserted backwards. In this configuration, (and with enough applied force), one of the hinge straps can then be manually pressed into an unintended locking position. If the compartment is put in backwards, you will eventually realize it and are able to backtrack (that is unless you also manually force hinge latches back into the box). The issue was always the hinge straps. When putting the puzzle back together, you can apply enough force to wedge internal mechanics apart and lock a hinge strap into place manually. This seemed like a logical assumption because that is the way latches on brief cases and suit cases relock. Just don't do this. The latches relock in the same way that they unlock, which is positioning things so they go in freely, then letting the internal mechanics engage them. Be mindful of how the straps eventually come out, so you can put them back in reverse order."